

# These are PLANS FOR EXPEDIENT FALLOUT SHELTERS

## SAVE THESE PLANS—THEY MAY SAVE YOUR LIFE

### ● GENERAL INFORMATION

WITHOUT PROTECTION, UNTOLD NUMBERS OF AMERICANS WOULD DIE NEEDLESSLY IN THE EVENT OF A NUCLEAR ATTACK. THE EXPEDIENT SHELTERS ILLUSTRATED IN THE FOLLOWING PAGES PROVIDE PROTECTION TO OCCUPANTS FROM THE DEADLY RADIATION OF RADIOACTIVE FALLOUT GENERATED BY A NUCLEAR DETONATION — THEIR USE CAN SAVE THE LIVES OF MILLIONS OF AMERICANS.

EVEN THOUGH THE ILLUSTRATED SHELTERS ARE VERY AUSTERE, THERE ARE A NUMBER OF THINGS THAT CAN BE DONE TO IMPROVE THEIR HABITABILITY AFTER THEY HAVE BEEN BUILT. WITH THE USE OF A LITTLE INGENUITY AND EFFORT, THE SHELTERS CAN BE MADE MORE COMFORTABLE. SOME OF THE THINGS THAT CAN BE DONE ARE:

- CONSTRUCT SEATS, HAMMOCKS, OR BUNKS.
- COVER THE FLOOR WITH BOARDS, PINE BOUGHS OR LOGS AND DRAPE SHEETS OR MATERIAL OVER THE EARTH WALLS.
- PROVIDE SAFE, DEPENDABLE LIGHT.
- FOR HOT WEATHER, CONSTRUCT THE EXPEDIENT AIR VENTILATION PUMP.
- FOR COOKING, CONSTRUCT THE EXPEDIENT COOK STOVE FOR USE IN THE ENTRY-WAY. IN COLD WEATHER, SEAL THE ENTRANCE AND USE THE STOVE FOR HEATING THE SHELTER AREA. BE SURE VENTILATION IS PROVIDED WHENEVER THE STOVE IS USED.
- STORE SHELTER SUPPLIES IN ENTRYWAY FOR MORE LIVING SPACE. COVER ALL OPEN CONTAINERS. RADIATION WILL NOT DAMAGE THESE SUPPLIES.

HUMANS MUST HAVE WATER AND FOOD TO LIVE. WHEN PEOPLE ARE TO LIVE IN A SHELTER FOR A WEEK OR TWO, SUFFICIENT FOOD AND SUPPLIES MUST BE PROVIDED FOR THE OCCUPANTS. THE MINIMUM NECESSITIES ARE:

- WATER — MINIMUM REQUIREMENTS (DEPENDENT UPON TEMPERATURE — LESS IN

COLD WEATHER, MORE IN WARMER) WILL BE FROM ONE QUART TO ONE GALLON PER PERSON PER DAY. STORAGE CAN BE ACCOMPLISHED BY USING DISINFECTED METAL OR PLASTIC TRASH CANS OR BOXES LINED WITH STRONG POLYETHYLENE FILM OR STRONG PLASTIC BAGS. FOR PURITY, EIGHT DROPS (ONE TEASPOON) OF A 5-1/2% CHLORINE SOLUTION (e.g., CLOROX) SHOULD BE MIXED INTO EACH 5 GALLONS OF WATER.

● FOOD — ALL FOOD SHOULD REQUIRE NO REFRIGERATION AND SHOULD BE BROUGHT TO THE SHELTER IN AIRTIGHT TINS OR BOTTLES. UNDER SHELTER CONDITIONS, PEOPLE WILL REQUIRE ABOUT HALF AS MUCH FOOD AS USUAL. FOODS SHOULD HAVE A HIGH NUTRITIONAL VALUE AND A MINIMAL AMOUNT OF BULK (i.e., CANNED MEATS — FRUITS — VEGETABLES, DRIED CEREALS, HARD CANDY, ETC.)

● SANITATION — A METAL CONTAINER WITH A TIGHT-FITTING LID FOR USE AS A TOILET WITH WHICH PLASTIC BAGS CAN BE USED. TOILET PAPER, SOAP, TOWELS, SANITARY ITEMS AND A QUANTITY OF STRONG PLASTIC BAGS WILL BE NEEDED.

● MEDICAL SUPPLIES — A WELL-STOCKED FIRST-AID KIT COMPARABLE TO WHAT IS USUALLY KEPT AT HOME. TAKE SPECIAL MEDICINES FOR INFANTS AND OTHERS AND A GOOD FIRST-AID HANDBOOK.

● CLOTHING AND BEDDING — SEVERAL CHANGES OF CLEAN CLOTHING, ESPECIALLY SOCKS AND UNDERCLOTHING — DEPENDENT UPON THE WEATHER, BLANKETS, PILLOWS AND SLEEPING BAGS MAY ALSO BE NEEDED.

● PORTABLE RADIO — LASTLY, BUT HARDLY LEAST IMPORTANT, A PORTABLE RADIO WITH FRESH AND EXTRA BATTERIES. RADIO STATION BROADCASTS WILL ADVISE YOU WHEN IT IS SAFE TO ABANDON THE SHELTER AND ALSO PROVIDE YOU WITH OTHER IMPORTANT EMERGENCY INFORMATION.

# EXPEDIENT FALLOUT SHELTER

## CAR-OVER-TRENCH

**GENERAL INFORMATION:** READ AND STUDY ALL INSTRUCTIONS BEFORE BEGINNING. IF A BIG STATION WAGON IS USED, SHELTER CAN BE PROVIDED FOR UP TO 6 PERSONS. LESS IF CAR IS SMALLER. THIS SHELTER CAN NOT BE BUILT IN AREAS WHERE GROUNDWATER OR ROCK IS CLOSE TO THE GROUND SURFACE. SHELTER CAN BE CONSTRUCTED BY TWO PERSONS WORKING A TOTAL OF ABOUT 8 HOURS EACH.

### STEP 1

SELECT A LEVEL SITE. DIG A SMALL TEST HOLE ABOUT 10 INCHES DEEP. REMOVE ALL LOOSE EARTH FROM THE BOTTOM. PUSH THE POINT OF YOUR THUMB INTO THE UNDISTURBED EARTH IN THE BOTTOM OF HOLE. IF YOU CANNOT PUSH YOUR THUMB DEEPER THAN ONE INCH, THE EARTH SHOULD BE SUITABLE FOR THIS SHELTER. IF THUMB PENETRATES DEEPER THAN ONE INCH, MOVE TO ANOTHER SITE AND REPEAT TEST. BECAUSE EARTH AT THE TESTED SITE IS NOT SUITABLE.

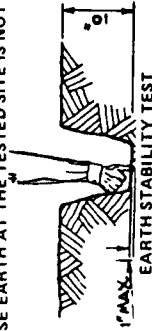

EARTH STABILITY TEST

### STEP 2

STAKE OUT DIMENSIONS SHOWN FOR TRENCH AND ENTRYWAY. NOTE THAT THE LENGTH OF TRENCH MUST BE 4 FEET LESS THAN THE OVERALL LENGTH OF THE CAR.

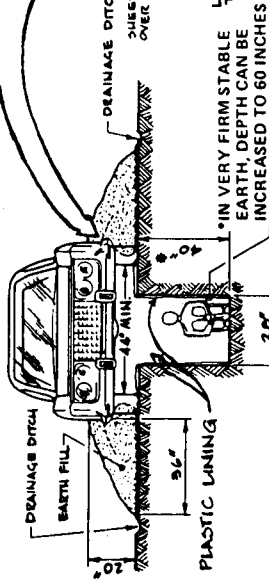

TRENCH AND FILL DETAIL

### ALTERNATIVE METHOD FOR SANDY SOILS

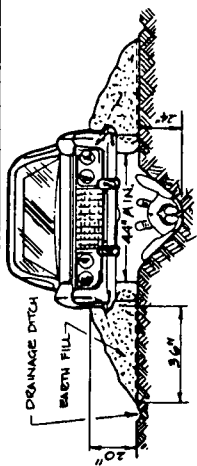

A "SIT IN" SHELTER CANNOT BE DUG IN BEACH TYPE SAND, BECAUSE THE TRENCH WALLS WILL CAVE IN. HOWEVER, A "LIE IN" TRENCH CAN BE DUG AS SHOWN ABOVE AND STILL PROVIDE GOOD FALLOUT PROTECTION. ALL OTHER STEPS REMAIN THE SAME.

### TOOLS AND MATERIALS

1. CAR: CAUTION: CAR MUST HAVE AT LEAST 44 INCHES OF WIDTH BETWEEN INSIDE WALLS OF TIRES.
2. PICK AND LONG-HANDLED SHOVEL.
3. PLASTIC SHEETING AND/OR CLOTH APPROX. 10-12 BEDSHEETS OR EQUIV. AREA OF OTHER MATERIALS WILL BE REQUIRED.
4. SANDBAGS, SACKS OR PILLOWCASES, 9 REQUIRED.
5. 50 FEET OF STRONG STRING OR CORD AND A KNIFE.
6. YARDSTICK OR MEASURING TAPE
7. WORK GLOVES FOR EACH WORKER.
8. STAKES, 4 REQUIRED.

### STEP 3

EXCAVATE TRENCH AND ENTRYWAY, AS TRENCH DEEPENS, REPEAT EARTH STABILITY TEST ON BOTTOM OF TRENCH. IF EARTH BECOMES "SOFTER" DO NOT DEEPEN TRENCH. PLACE EXCAVATED EARTH AWAY FROM TRENCH SO THAT CAR CAN BE DRIVEN OVER TRENCH.

### STEP 4

LINE TRENCH WITH PLASTIC OR CLOTH. LINING SHOULD TOUCH FLOOR OF TRENCH AND EXTEND OUTWARD TO THE LIMIT OF EARTH FILL. AFTER TRENCH IS LINED, CAREFULLY DRIVE CAR OVER TRENCH TO THE POSITION SHOWN. HAVE SOMEONE GUIDE THE DRIVER OVER THE TRENCH.

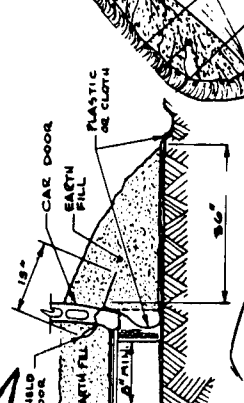

- STEP 5 REMOVE ALL SEATS (IF POSSIBLE). COVER FLOOR AND TRUNK WITH PLASTIC; PLACE 1 FOOT OF EARTH FILL IN TRUNK AND ON FLOOR.

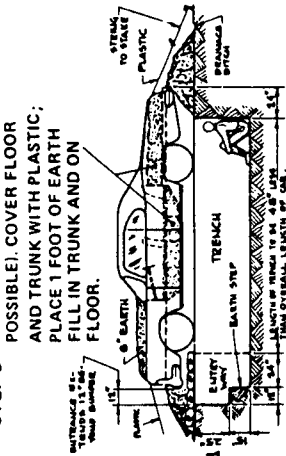

### TRENCH AND ENTRYWAY DETAIL

### STEP 6

PLACE PLASTIC COVER OVER ENTRANCE AND VENTILATION OPENINGS. SECURE UNDER HOOD AND TRUNK LID.

### STEP 7

SECURE PLASTIC TO SIDES OF CAR AS SHOWN HERE AND ABOVE. USE WOOD OR STICK WEDGES AT HOOD AND TRUNK TO HOLD PLASTIC. ALSO SECURE WITH DOOR AS SHOWN ABOVE.

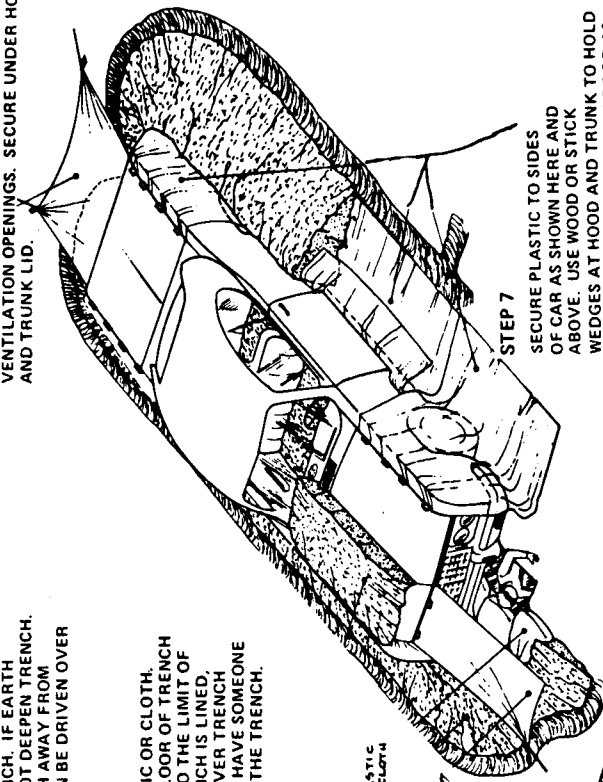

### STEP 8

BANK EARTH AROUND CAR TO HEIGHT OF 20 INCHES

### STEP 9

PLACE SANDBAGS AROUND ENTRANCE AND BANK EARTH AROUND THEM.

### STEP 10

PLACE 8 INCHES OF EARTH ON CAR HOOD

### STEP 11

DIG SHALLOW DRAINAGE DITCH AROUND FILL.

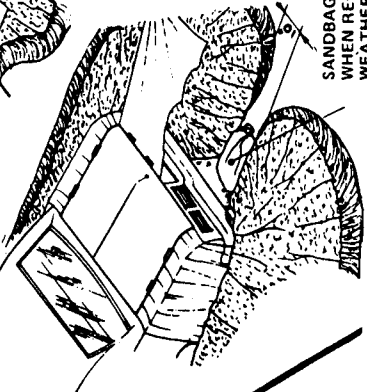

SANDBAG TO REDUCE AIRFLOW WHEN REQUIRED DURING COLD WEATHER

# EXPEDIENT FALLOUT SHELTER

## TILT-UP DOORS AND EARTH

### GENERAL INFORMATION

READ AND STUDY ALL INSTRUCTIONS BEFORE STARTING TO BUILD. THE LOCATION SELECTED FOR THIS SHELTER SHOULD BE LEVEL OR GENTLY SLOPING DOWN AND AWAY FROM THE MASONRY WALL. A THREE-PERSON SHELTER CAN BE CONSTRUCTED BY THREE PEOPLE WORKING A TOTAL OF 6 HOURS EACH.

### STEP 1

LAY OUT THE TRENCH AND EARTH NOTCH WIDTHS, AS DIMENSIONED ON THE SECTION BELOW, ADJACENT TO A MASONRY WALL. DETERMINE THE LENGTH OF TRENCH AND NOTCH BY ALLOWING ONE DOOR WIDTH OF LENGTH PER PERSON TO BE SHELTERED.

### STEP 2

EXCAVATE TRENCH AND EARTH NOTCH. PLACE EXCAVATED EARTH OUTSIDE SHELTER LIMITS FOR LATER USE.

### STEP 3

REMOVE DOOR KNOBS FROM ALL DOORS. PLACE DOUBLE LAYER OF DOORS IN NOTCH AND AGAINST WALL AS SHOWN IN SKETCH. NAIL 1 1/2" x 8" BOARD TO DOOR EDGES AT ENTRANCE TO SERVE AS EARTH STOP. AFTER ATTACHING PLASTIC ENTRANCE COVER AS SHOWN, OR BUILD RETAINING WALL OF SANDBAGS IN LIEU OF BOARD. PLACE ONE DOOR ON EDGE LENGTHWISE AS THE END CLOSURE.

### STEP 4

PLACE ONE END OF THE ROLLED UP WATERPROOFING MATERIAL UNDER THE TOP EDGE OF THE DOORS BEFORE EARTH FILL IS PLACED. BEGIN PLACEMENT OF EARTH FILL ON DOORS. COVER THE EARTH FILL WITH WATERPROOFING MATERIAL, SECURING IT WITH EARTH THAT TOP AND BOTTOM TO PREVENT IT FROM BLOWING AWAY.

### STEP 5

CONSTRUCT ENTRANCE - FILL "SANDBAG PILLOW" WITH EARTH TAKEN FROM THE TRENCH AND STACK TO DIMENSIONS SHOWN AFTER DOORS ARE IN PLACE. PLASTIC OR POLYETHYLENE (WATERPROOFING MATERIAL) ENTRANCE COVER SHOULD BE IN PLACE BEFORE EARTH FILL IS PUT ON THE DOORS.

### TOOLS AND MATERIALS

1. TOOLS: PICK, SHOVEL, HAMMER, SAW, SCREWDRIVER, KNIFE, YARDSTICK.
2. SANDBAGS PILLOWCASES OR PLASTIC GARBAGE BAGS - AT LEAST 39.
3. LUMBER: 1 1/2" x 8" PIECE 7' LONG (OR 20 MORE SANDBAGS) FOR EARTH-FILL STOP AT ENTRANCE EDGE OF DOORS.
4. ROPE OR CORD TO TIE SAND BAGS.
5. DOORS: TWO LAYERS FOR LENGTH OF SHELTER PLUS ONE FOR END CLOSURE. (EXAMPLE: 7 DOORS FOR 3 PERSON SHELTER).
6. NAILS: 8 PERRY (2 1/2" LONG), ABOUT 10 TO NAIL EARTH STOP TO DOOR EDGES AT ENTRANCE.
7. PLASTIC OR POLYETHYLENE (WATERPROOFING MATERIAL) TO COVER DOUBLE LAYER OF DOORS PLUS ENTRANCE.
8. WORK GLOVES FOR EACH WORKER.

### ENTRY DETAIL

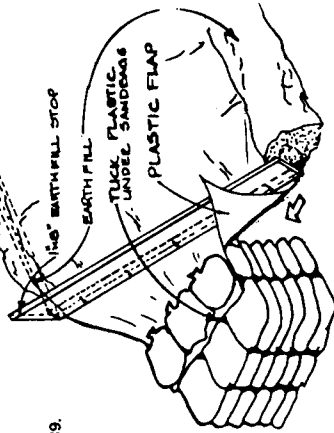

IF BLDG WALL IS NOT MASONRY - STACK SANDBAGS ON INSIDE OF WALL THE HEIGHT AND WIDTH OF SHELTER.

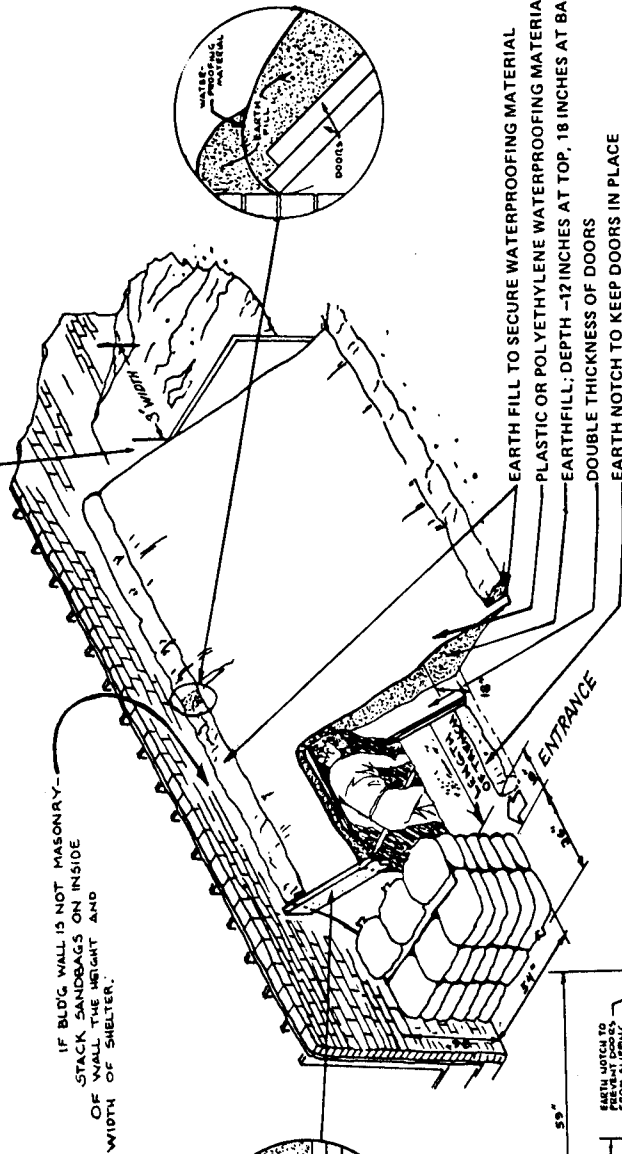

- EARTH FILL TO SECURE WATERPROOFING MATERIAL
- PLASTIC OR POLYETHYLENE WATERPROOFING MATERIAL
- EARTH FILL: DEPTH - 12 INCHES AT TOP, 18 INCHES AT BASE
- DOUBLE THICKNESS OF DOORS
- EARTH NOTCH TO KEEP DOORS IN PLACE

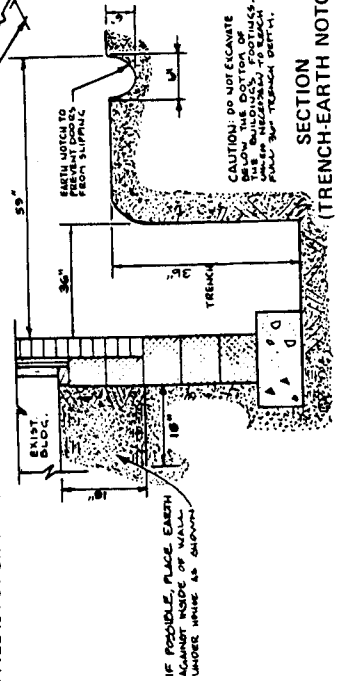
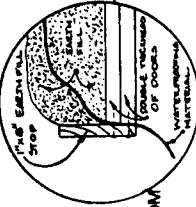

CAUTION: DO NOT EXCAVATE BELOW THE BOTTOM OF SANDBAG PILLOW. USE EARTH TAKEN FROM TRENCH TO BUILD UP EARTH NOTCH TO KEEP DOORS IN PLACE.

SECTION (TRENCH-EARTH NOTCH)

# EXPEDIENT FALLOUT SHELTER

## ABOVE-GROUND DOOR-COVERED SHELTER

### GENERAL INFORMATION

THE ABOVE-GROUND DOOR-COVERED SHELTER IS DESIGNED FOR AREAS WHERE BELOW-GROUND SHELTERS ARE IMPRACTICAL BECAUSE THE GROUNDWATER TABLE OR BEDROCK IS CLOSE TO THE GROUND SURFACE. THIS SHELTER CAN BE BUILT BY FOUR PERSONS WORKING A TOTAL OF 10 HOURS EACH.

READ AND STUDY ALL INSTRUCTIONS BEFORE STARTING TO BUILD. IF DOOR WIDTHS MEASURE LESS THAN 32 INCHES, USE A COMBINATION OF DOORS TO PROVIDE A MINIMUM OF 32 INCHES OF DOOR-WIDTH PER PERSON.

### STEP 1

SELECT A SHELTER LOCATION WHERE THERE IS LITTLE OR NO CHANCE OF RAINWATER PONDING ON THE GROUND SURFACE. STAKE OUT SHELTER, REMOVE DOOR KNOBS. ALLOW 1 DOOR FOR EACH PERSON PLUS 1 DOOR FOR ENTRY/EXIT AT ENCL. LIMIT IS 8 PERSONS PER SHELTER.

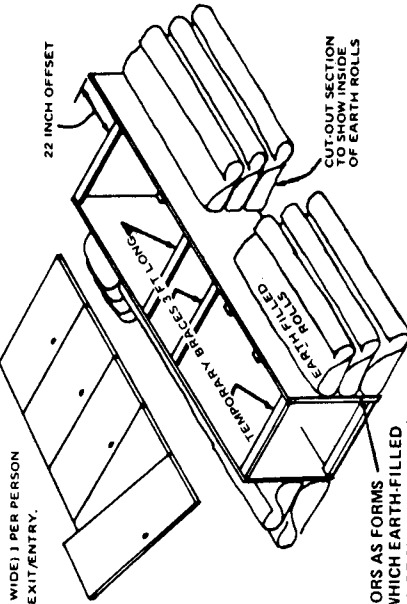

### STEP 2

SET UP DOORS AS FORMS AROUND WHICH EARTH-FILLED ROLLS WILL BE PLACED. NAIL ONLY TOP BRACES. NAILS MUST BE REMOVED LATER. BRACE ALL CORNERS, CENTER, TOP AND BOTTOM OF EACH DOOR.

### STEP 3

BEGIN TO PLACE EARTH-FILLED ROLLS AGAINST DOOR FORMS. TO FORM EARTH ROLLS, SEE EARTH-FILLED ROLL DETAIL BOTTOM OF PAGE.

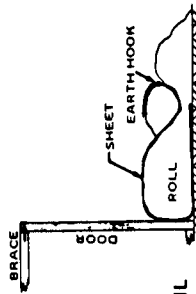

### EARTH-FILLED ROLL DETAIL

1. PLACE 2 FT OF SHEET ON GROUND AND TEMPORARILY DRAPE REMAINDER OF SHEET ON DOOR.
2. PLACE EARTH ON SHEET - SHAPE AS SHOWN.
3. FOLD SHEET OVER SHAPED EARTH.
4. PLACE EARTH ONTO SHEET AT NARROW TRENCH.
5. FOLD SHEET TO FORM EARTH HOOK. HOOK WILL ANCHOR SHEET.
6. REPEAT TO FORM NEXT EARTH-FILLED ROLL.

### STEP 4

DIG 14" DEEP, 36" WIDE TRENCH INSIDE SHELTER. EARTH CAN BE USED TO FORM SIDE EARTH FILLED ROLLS. TRENCH CAN BE MADE UP TO 3 FEET DEEP IF CONDITIONS PERMIT.

### STEP 5

MOUND EARTH AGAINST THE EARTH-FILLED ROLLS AS SHOWN. CONTINUE PLACING EARTH AND SHEETS TO FORM EARTH-FILLED ROLLS.

### STEP 6

KEEP HEIGHT OF EARTH ABOUT EQUAL ON BOTH SIDEWALLS AS ROLLS ARE FORMED. AFTER SIDEWALLS HAVE REACHED PLANNED HEIGHT, REMOVE BRACES AND DOOR FORMS. USE SAME DOOR FORMS TO CONSTRUCT ENDWALLS WITH EARTH FILLED ROLLS. PROVIDE EXIT/ENTRY AT END AS SHOWN.

### STEP 7

REMOVE DOOR FORMS FROM ENDWALLS. POSITION ROOF DOORS IN THEIR FINAL POSITION. PLACE ENTRY FRAME FOR DOOR OVER ENTRY/EXIT. PLACE WATERPROOFING MATERIAL ON DOORS.

### STEP 8

PLACE 15 INCHES OF EARTH ON TOP OF SHELTER. IN HOT WEATHER CONSTRUCT A SHELTER VENTILATION AIR PUMP. SEE AIR PUMP DETAILS ON LAST PAGE.

### PLAN VIEW OF SHELTER (4 PERSON)

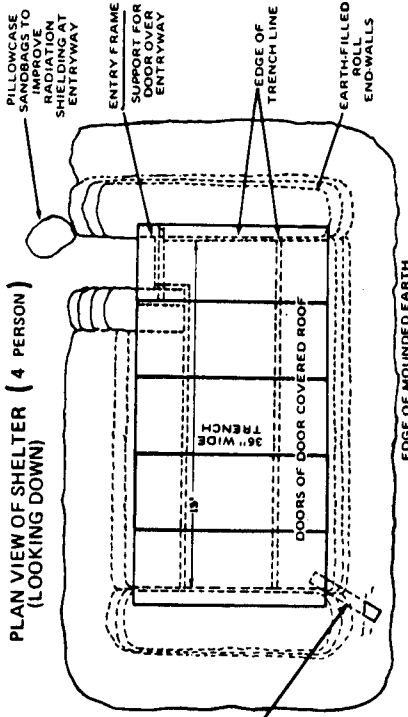

### TOOLS AND MATERIALS

1. Doors as indicated.
2. Pick or Mattock and Shovel.
3. Two Buckets or Large Cans to Carry Earth.
4. Tape Measure, Yardstick or Ruler.
5. Saw, Axe or Hatchet.
6. Hammer and at least 20 Nails - 2 1/2" long.
7. At least 4 Double Bed Sheets - Each Person to be Sheltered.
8. Pillowcases and Waterproofing Materials such as Plastic or Polyethylene.
9. Work Gloves for Each Worker.
10. Lumber for use as Temporary Braces and for Entry/Exit Frame.

### ENTRY/EXIT FRAME

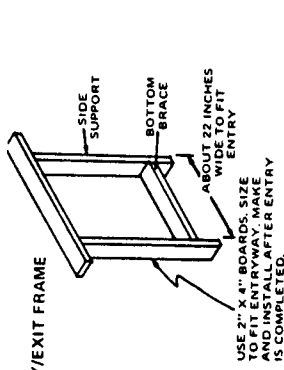

FOLD WATERPROOFING MATERIAL UNDER HIGHER EDGE OF DOOR TO KEEP IT FROM SLIPPING.

NOTE: IF TRENCHING IS IMPRACTICAL HEIGHTEN WALLS BY USING ADDITIONAL EARTH ROLLS.

PULL DOWN SANDBAGS TO IMPROVE RADIATION SHIELDING AT ENTRYWAY

ENTRY FRAME SUPPORT FOR DOOR OVER ENTRYWAY

EDGE OF TRENCH LINE

EARTH-FILLED ROLL END WALLS

36" WIDE TRENCH

DOORS OF DOOR COVERED ROOF

EDGE OF MOUNDED EARTH

22 INCH OFFSET

CUT-OUT SECTION TO SHOW INSIDE OF EARTH ROLLS

PROVIDE 4-6" DIA. PIPE FOR VENTILATION

# EXPEDIENT FALLOUT SHELTER

## LOG-COVERED TRENCH SHELTER

### GENERAL INFORMATION

THIS SHELTER IS DESIGNED FOR AREAS WHERE THE DEPTH BELOW THE GROUND SURFACE TO HARD ROCK OR GROUNDWATER IS BELOW THE BOTTOM OF THE TRENCH. ALSO, THE EARTH MUST BE SUFFICIENTLY FIRM AND STABLE SO THAT THE TRENCH SIDEWALLS WILL NOT CAVE IN. IN ADDITION, ADEQUATE SMALL TREES THAT CAN BE CUT FOR LOGS MUST BE AVAILABLE IN THE IMMEDIATE AREA. THE SHELTER (4-PERSON CAPACITY) CAN BE BUILT BY 4 PEOPLE WORKING A TOTAL OF 12 HOURS EACH. AFTER INITIAL COMPLETION, THE SHELTER CAN BE ENLARGED TO A WIDTH OF 5 FT., 6 IN. AND DEEPENED TO 6 FT. HOWEVER, 9-FT LOGS MUST BE USED IN PLACE OF 7-FT LOGS AND THE BURIED ROOF MUST BE LARGE ENOUGH TO COVER THE WIDENED SHELTER DURING THE INITIAL CONSTRUCTION.

### STEP 1

CLEAR AREA OF BRUSH AND TALL GRASS. LAYOUT SHELTER AS SHOWN BELOW.

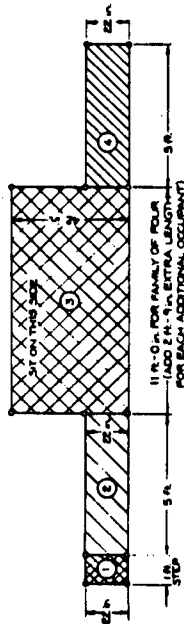

### LEGEND

○ = WOOD OR METAL STAKE

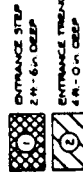

### STEP 2

BEGIN EXCAVATING THE TRENCH. PLACE EXCAVATED EARTH AT LEAST 3 FEET BEYOND THE EDGE OF TRENCH SO THAT THE ROOF LOGS CAN LATER BE PLACED OVER THE TRENCH.

### STEP 3

AS THE TRENCH EXCAVATION PROGRESSES, SOME WORKERS SHOULD BEGIN CUTTING LOGS TO THE LENGTH AND SIZE AS SHOWN ON THE ILLUSTRATIONS.

ALTERNATE BIG AND SMALL ENDS OF LOGS THROUGHOUT ACROSS SHELTER ROOM.

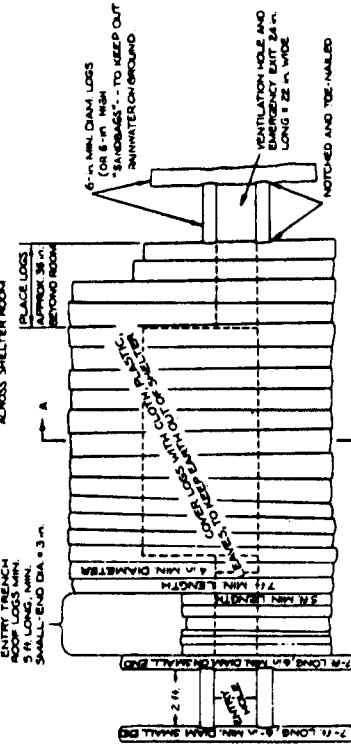

ROOF LOGS = MINIMUM 7-ft LOGS, 4 IN. MINIMUM DIAMETER ON SMALL END LAID ABOUT 2 FT. APART EACH END OF SHELTER ROOM.

PLAN VIEW OF TOP OF SHELTER

### STEP 4

PLACE LOGS OVER TRENCH. POSITION TIES FOR BED, SHEET CHAIRS OR HAMMOCKS. PLACE NEWSPAPER OR OTHER MATERIAL AS INDICATED OVER LOGS. PLACE EARTH FILL AND BURIED ROOF.

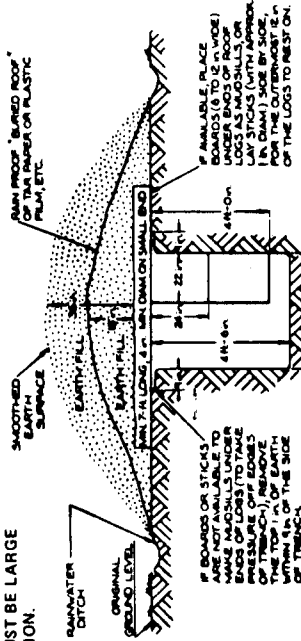

### SECTION A-A

### STEP 5

CONSTRUCT CANOPIES OVER THE OPENINGS.

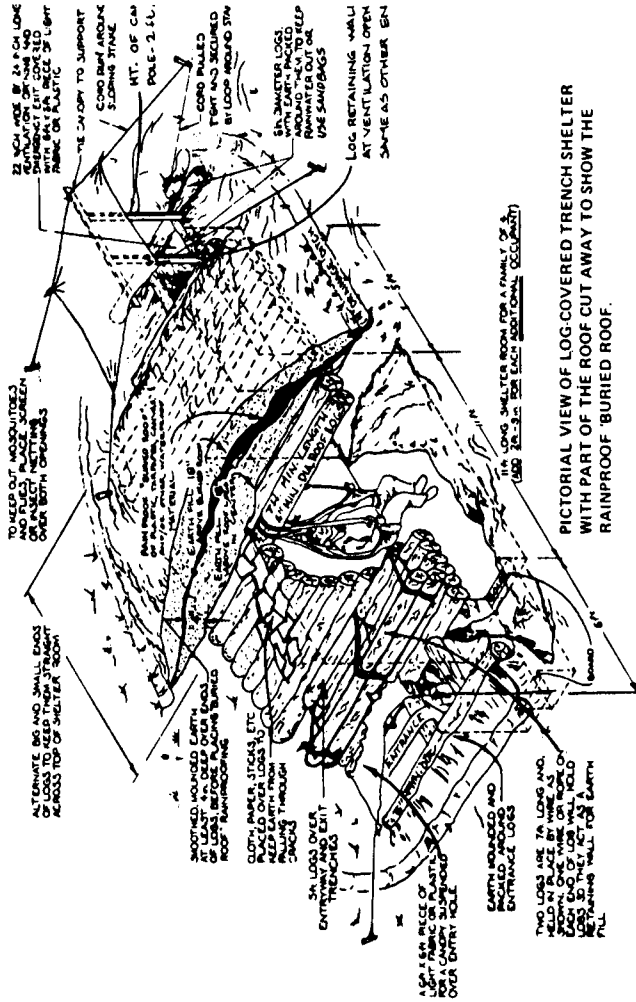

PICTORIAL VIEW OF LOG-COVERED TRENCH SHELTER WITH PART OF THE ROOF CUT AWAY TO SHOW THE RAINPROOF BURIED ROOF.

### TOOLS AND MATERIALS

1. SAW AND/OR AXE.
2. PICK OR MATTOCK.
3. LONG-HANDLED SHOVELS.
4. RAINPROOFING MATERIAL (PLASTIC OR POLYETHYLENE) 25 SQUARE YARDS. FOR EACH PERSON ABOVE 4, ADD 2 SQ. YDS.
5. 50 FEET OF STRONG STRING OR CORD AND A KNIFE.
6. TAPE MEASURE OR YARD STICK.
7. AT LEAST 8 PILLOW CASES AND/OR SANDBAGS.
8. WORK GLOVES.
9. BED SHEETS FOR USE AS "CHAIRS" OR "HAMMOCKS" - 1 PER PERSON PLUS AT LEAST 15 FEET OF STRONG ROPE OR CORD PER BED SHEET.
10. 15 POUNDS OF NEWSPAPERS TO PLACE OVER ROOF LOGS TO KEEP EARTH FROM FALLING THROUGH CRACKS BETWEEN LOGS.

APPROX. NO. OF POLES REQ'D.	
45 - 7' LONG	4" DIA.
10 - 5' "	4" "

PICTORIAL VIEW OF LOG-COVERED TRENCH SHELTER WITH PART OF THE ROOF CUT AWAY TO SHOW THE RAINPROOF BURIED ROOF.

# EXPEDIENT FALLOUT SHELTER

## ABOVE-GROUND RIDGE-POLE

### GENERAL INFORMATION

THIS SHELTER IS DESIGNED FOR AREAS WHERE THERE IS AN ABUNDANCE OF SMALL TREES AND BELOWGROUND SHELTERS ARE IMPRACTICAL. THE SHELTER (5-PERSON CAPACITY) CAN BE BUILT BY 3 PEOPLE WORKING A TOTAL OF 18 HOURS EACH. READ AND STUDY ALL INSTRUCTIONS BEFORE BEGINNING.

5-PERSON SHELTER IS ILLUSTRATED - RIDGE POLE 1 FT. LONGER FOR 6 TO 8 PERSONS; USE 3 COLUMN POLES - 10 TO 12 PERSONS; USE 4 COLUMNS.

### TOOLS AND MATERIALS

- SAW TO CUT GREEN POLES (BOM OR CROSSCUT SAW PREFERRED) AND AN AXE.
- SHOVEL OR SHOVEL FOR EACH TWO WORKMEN.
- TO CARRY EARTH, CURS, OR EACH TWO WORKMEN.
- THESE DOUBLE BED SHEETS FOR THE ILLUSTRATED 5-PERSON SHELTER, OR AN EQUIVALENT AREA OF SHEET FOR EACH ADDITIONAL OCCUPANT. IF ADDITIONAL AVAILABLE, USE STICKS AND SMALL POLES PLACED LEAVES TO FILL IN THE SPACES BETWEEN THE POLES. HAMMER AND AT LEAST 40 NAILS (3 IN. OR LONGER), OR ADDITIONAL BED SHEETS OR OTHER FABRIC EQUALLY STRONG, FOR EACH PERSON TO BE SHELTERED TO WHEN TWISTED, 1/2" WIDE STRIPS TO SERVE AS "ROPE" AT LEAST 2 SQUARE YARDS PER PERSON OF PAINTED CLOTH, PLASTIC MATRESS COVERS, ETC. - ESSENTIAL IN RAINY COLD WEATHER.
- GLOVES TO PREVENT INJURY AND BLISTERS TO HANDS.

### STEP 1 CONSTRUCT RIDGE POLE FRAME

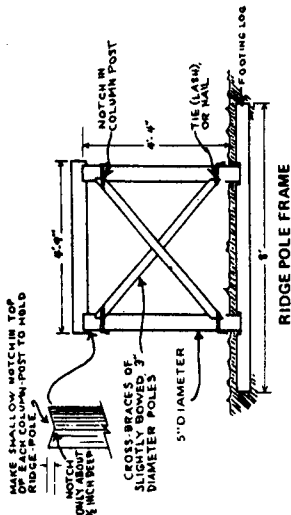

SIDE VIEW SHOWING CROSS BRACES OF COLUMN POSTS (IF SLOPING CROSS BRACES ON OPPOSITE SIDES OF THE COLUMN, USE ONE FOR EACH SIDE WITH ONE END OF PAIR OF POSTS AND SLOPE BRACES ALTERNATELY IN DIFFERENT DIRECTION.)

### STEP 2

DIG 4" DEEP "V" TRENCH IN EARTH AND PLACE 9 ROOF POLES IN TRENCH AND ON RIDGE-POLE FRAME AS SHOWN.

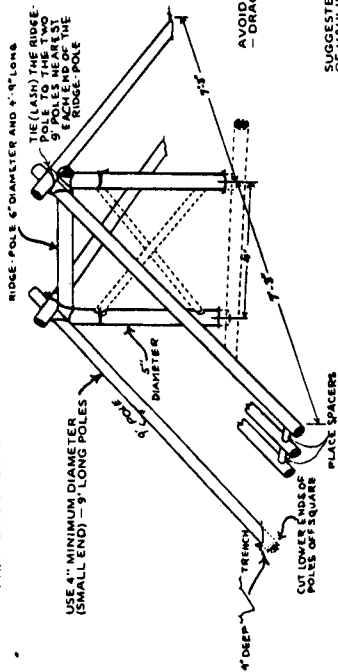

AVOID CARRYING POLES - DRAG THEM

SUGGESTED WAY OF HAULING POLES

### STEP 3 CONSTRUCT ENTRYWAY

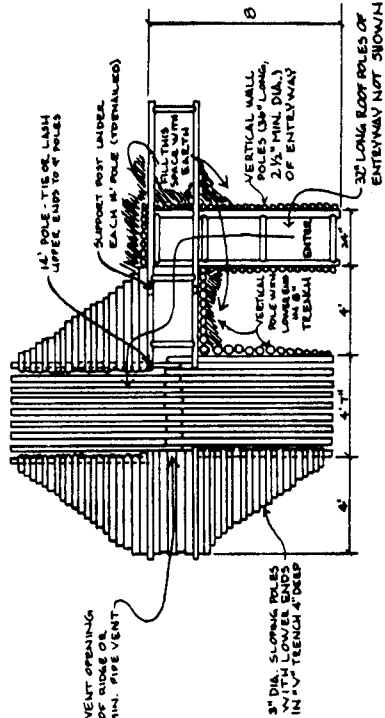

VIEW LOOKING DOWN ON SHELTER WITH ALL POLES IN PLACE EXCEPT THE ROOF POLES OF THE ENTRYWAY

### STEP 4

PLACE LIMBS OR STICKS AND BEDSHEETS ACROSS ROOF POLES. PLACE EARTH FILL AND WATERPROOFING MATERIALS AS ILLUSTRATED.

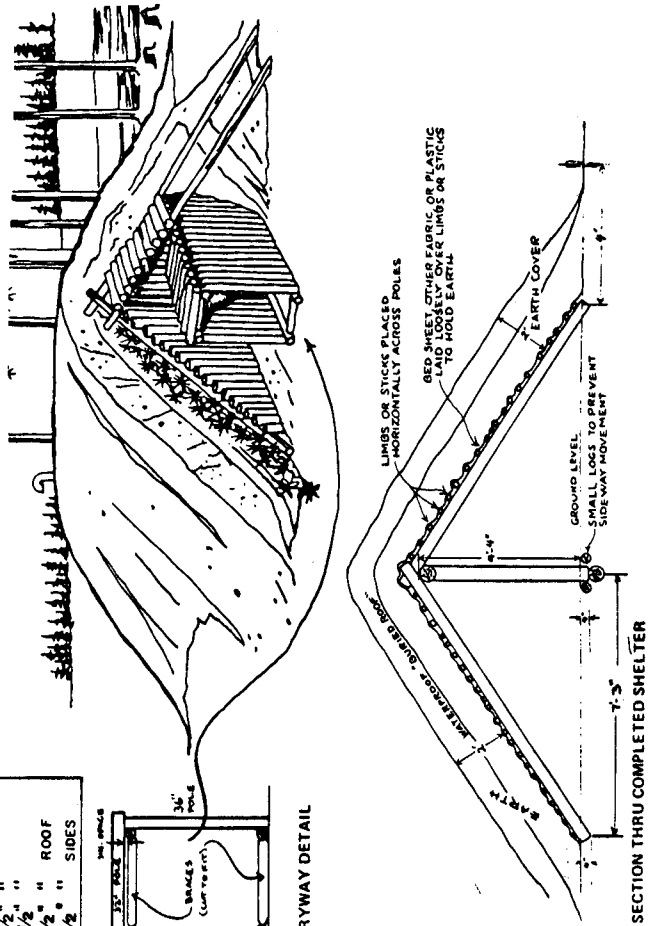

APPROX. NUMBER OF POLES REQ'D.	
20 POLES	9' LONG x 4" DIA.
1	49" x 6"
2	4'4" x 5"
2	14' x 4"
2	6' x 3"
1	8' x 6"
SHELTER SIDES	
40 POLES	3'-4 1/2" x 2 1/2"
24	1'-4 1/2" x 2 1/2"
120	2'-6" x 3"
ENTRY	
4	8' x 2 1/2"
13	20" x 2 1/2"
48	32" x 2 1/2"
64	36" x 2 1/2"
ROOF SIDES	

# EXPEDIENT FALLOUT SHELTER

## CRIB-WALLED SHELTER (ABOVE GROUND)

### GENERAL INFORMATION

THIS SHELTER CAN BE CONSTRUCTED IN AREAS WHERE THERE IS AN ABUNDANCE OF SMALL TREES. THE APPROXIMATE AMOUNT OF TIME AND EFFORT REQUIRED TO BUILD THIS SHELTER (CAPACITY 5) IS LISTED IN TABLE 1. READ AND STUDY ALL INSTRUCTIONS BEFORE STARTING TO BUILD.

### TOOLS & MATERIALS

(FOR 5-PERSON CAPACITY)

1. SAW AND/OR AXE TO CUT TREE POLES.
2. SHOVELS (ONE FOR EACH TWO WORKERS).
3. LARGE CANS, BUCKETS AND/OR POTS WITH BAILS/HANDLES TO CARRY EARTH.
4. BAILS/HANDLES TO CARRY EARTH.
5. AT LEAST 300 FT. OF STRONG WIRE OR 300 FT. OF ROPE, OR 8 DOUBLE-BED SHEETS (TO TEAR INTO 150 FT. LENGTHS), FOR EACH ADDITIONAL PERSON ABOVE 5. 20 FT. OF ROPE, OR HALF A DOUBLE-BED SHEET IS NEEDED.
6. AT LEAST 30 SQUARE YARDS, PLUS 2 SQUARE YARDS PER PERSON, OF PLASTIC OR WATERPROOF SHEET MATERIALS (SHOWER CURTAINS, PLASTIC TABLE CLOTHS, PLASTIC MATTRESS COVERS, ETC.).
7. 15 DOUBLE-BED SHEETS FOR EACH STRONG AS-BED SHEETS, 2 ADDITIONAL SHEETS PER PERSON ABOVE 5.
8. 15 POUNDS OF NEWSPAPER FOR ROOF COVER.
9. 15 POUNDS OF NEWSPAPER FOR ROOF COVER.

FLOOR PLAN

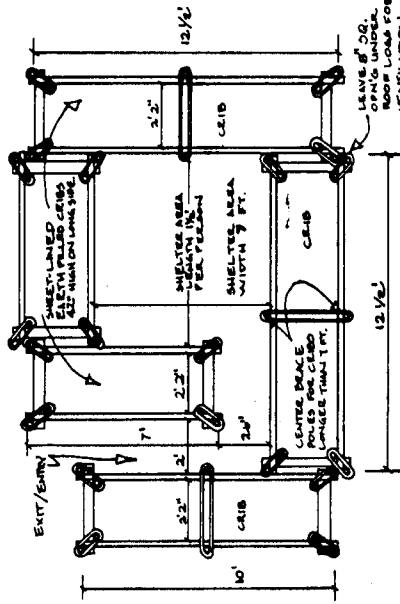

APPROX. NUMBER OF POLES	12 1/2" LONG	3" DIAMETER
28	14	" x 3"
14	10	" x 3"
20	9	" x 4"
10	5	" x 4"
28	7	" x 3"
60	42	" x 3"
46	42	" x 2 1/2"

WATERPROOF MATERIAL SLOPED TO DRAIN

SUGGESTED WAY OF HAULING POLES

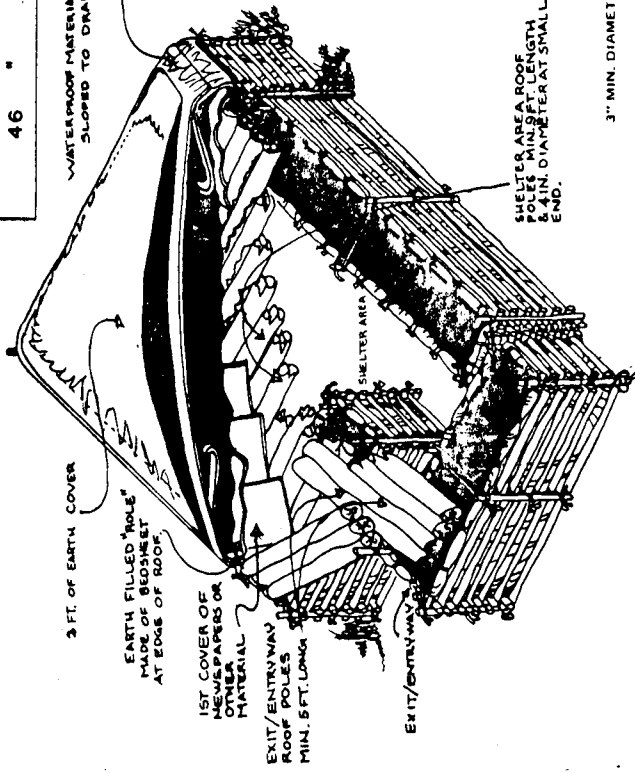

SHELTER AREA ROOF POLES MIN. 5 FT. LENGTH & 4 IN. DIAMETER AT SMALL END.

3" MIN. DIAMETER SIDE POLES

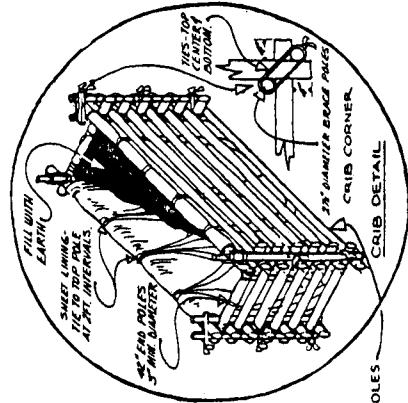

### STEP 1

SELECT A SHELTER LOCATION WHERE THE GROUND BEING COVERED WITH WATER IF IT RAINS HARD. STAKE OUT THE ENTIRE SHELTER, LOCATING THE 5 REQUIRED CRIBS.

### STEP 2

CUT POLES HAVING TOPS WITH DIAMETERS (NOT INCLUDING BARK) NO SMALLER THAN THE DIAMETERS SPECIFIED ON THE ILLUSTRATION FOR EACH TYPE POLE.

### STEP 3

CURT THE POLES BY SIZE (LENGTH AND DIAMETER) AND LAY ALL POLES SO THAT POLES ARE SMOOTH. DETERMINE IF ENOUGH LONG AND LIMBS POLES CAN BE OBTAINED FOR THE SIDE POLES OF THE 2 CRIBS ON THE LONG SIDES OF THE SHELTER. USUALLY, IF THE SHELTER IS TO BE BUILT BETTER TO USE 3 CRIBS PLACED END TO END INSTEAD OF ONE CRIB THAT REQUIRES THE LONGER POLES.

### STEP 4

1. PLACE TWO SIDE POLES ON THE GROUND AND PUT 2 OF THE ENDS OF ALL 4 POLES STICK OUT AT LEAST 10 FEET BEYOND WHERE THEY CROSS.
2. MAKE THE PAIRS OF END POLES AND SIDE POLES TO MAKE THE CRIB. KEEP THE TOP POLES OF THE CRIB LEVEL. ALTERNATE THE DIRECTION OF THE BIG AND SMALL ENDS OF THE POLES.
3. 4 CORNERS OF THE CRIB. BRACE CORNER BRACE POLES IN EACH OF THE POLES TO WHICH THEY WILL BE TIED.
4. TOP USING 3 FT. LENGTHS OF WIRE, ROPE, OR TWISTED 1/2 FT. WIDE STRIPS OF CLOTH.
5. THE CRIBS MORE THAN 7 FT. LONG, PLACE A PAIR OF CENTER BRACE POLES IN THE MIDDLE OF EACH LONG CRIB. TIE THE PAIR OF BRACE POLES IN POSITION OF ONE AGAINST THE OUTSIDE OF EACH LONG CRIB. TIE THE PAIR OF BRACE POLES TOGETHER PERMANENTLY, JUST ABOVE THE GROUND. LINE THE CRIB WITH CLOTH OR PLASTIC FILM, MAKING SURE AT LEAST A FEW INCHES OF LINING HANGS OVER THE UPPERMOST WALL POLE EVERY 2 FEET. EDGE OF FILM FINISH INTO THE UPPERMOST THROUGH WHICH TO THREAD THE TIE STRING OR A 1/2" WIDE STRIP OF CLOTH.
6. TIE TOGETHER THE CENTER BRACE POLES USING HORIZONTAL TIES AT CENTER AND TOP.
7. HORIZONTAL TIES AT CENTER AND TOP.
8. HORIZONTAL TIES AT CENTER AND TOP.
9. ETC., HAVE BEEN REMOVED.

### STEP 5

PUT THE 9-FT. ROOF POLES IN PLACE. PLACE THE STRONGEST POLES AT THE ENTRYWAY. THEN PLACE THE SHORTER (5 TO 6 FT) POLES OVER THE ENTRYWAY.

### STEP 6

TO KEEP EARTH FROM FALLING BETWEEN THE CRACKS OF THE ROOF, PUT STICKS IN THE LARGER CRACKS AND COVER THE ROOF WITH TWO OR MORE THICKNESSES OF NEWSPAPER OR OTHER MATERIAL.

### STEP 7

PUT EARTH COVER ON THE ROOF TO THE DEPTHS SHOWN ON THE ILLUSTRATIONS. BE SURE TO SLOPE THE MOUND OF EARTH SURFACE DOWN TO THE ENTRYWAY. USE BEDSHEETS TO FORM "EARTH ROLLS" AT THE ROOF EDGE. SHEETS WILL SERVE AS FORMS TO HOLD EARTH IN PLACE. CLUMPS OF EARTH WILL BE PLACED AT ROOF EDGES FOR THE BEDSHEETS. PLACE THE WATERPROOFING MATERIAL BEFORE PLACING THE FINAL 6 INCHES OF EARTH COVER.

### STEP 8

IF THE WEATHER IS HOT BUILD AND INSTALL A SHELTER VENTILATING PUMP. SEE SEPARATE INSTRUCTIONS ON VENTILATION FOR EXPEDIENT SHELTERS.

# EXPEDIENT FALLOUT SHELTER

## AIR VENTILATION PUMP — EMERGENCY LAMP — BUCKET STOVE

ALL EXPEDIENT SHELTERS ARE DESIGNED TO PROVIDE FOR SOME NATURAL VENTILATION. IN VERY HOT WEATHER, ADDITIONAL VENTILATION MAY BE REQUIRED TO PROVIDE A LIVABLE TEMPERATURE. CONSTRUCTION OF AN AIR PUMP THAT CAN PROVIDE ADDITIONAL VENTILATION IS ILLUSTRATED BELOW.

STUDY ALL INSTRUCTIONS BEFORE STARTING CONSTRUCTION

### STEP 1 AIR PUMP

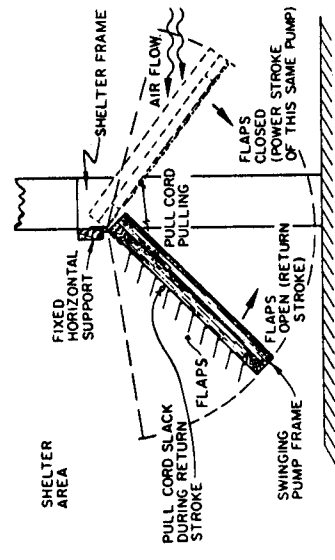

THE AIR PUMP OPERATES BY BEING SWUNG LIKE A PENDULUM. IT IS HINGED AT THE TOP OF ITS SWINGING FRAME. IT IS SWUNG BY PULLING AN ATTACHED CORD. THE FLAPS ARE FREE TO ALSO SWING AND WHEN THEY ARE IN THE CLOSED POSITION, AIR IS PUSHED THROUGH THE OPENING THAT THE PUMP IS ATTACHED TO.

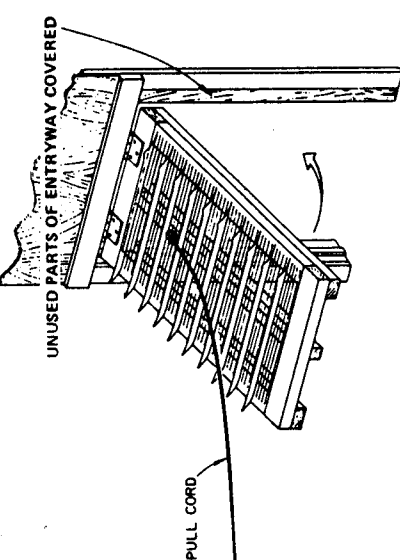

TO OBTAIN MAXIMUM EFFICIENCY AND MOVE THE LARGEST AMOUNT OF AIR, THE UNUSED PORTIONS OF THE ENTRYWAY SHOULD BE COVERED WITH WOOD, PLASTIC, CLOTH, STIFF PAPER OR SIMILAR MATERIALS.

### STEP 3 HOW TO CONSTRUCT THE AIR PUMP

#### A. CUT LUMBER AND ASSEMBLE FRAME AS SHOWN

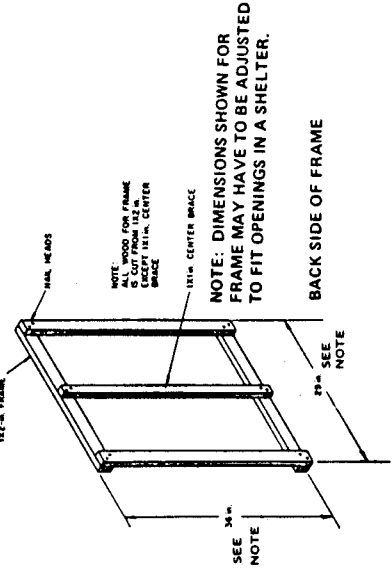

#### B. COMPLETE FRAME AND ATTACH HINGES. IF DRILL IS NOT AVAILABLE TO DRILL SCREW HOLES TO ATTACH HINGES, USE A NAIL TO MAKE THE HOLES.

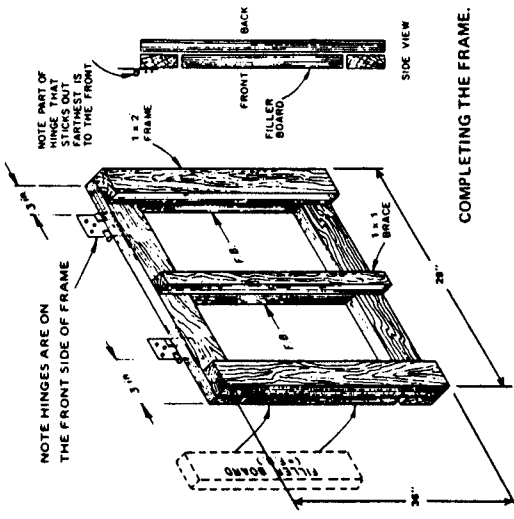

### STEP 2 MATERIALS AND TOOLS NEEDED TO CONSTRUCT AN AIR PUMP

(MATERIALS SIZED FOR A 36-INCH BY 29-INCH PUMP) LUMBER SIZES CAN BE ALTERED, DEPENDING ON AVAILABILITY.

*A. LUMBER	SIZE	QUANTITY	SIZE	QUANTITY
	1" X 2" X 36"	2	1" X 2 1/2" X 32"	2
	1" X 1" X 36"	1	1" X 1" X 32"	1
	1" X 2" X 29"	2	1" X 4" X 36"	1

- \*B. ONE PAIR ORDINARY DOOR OR CABINET BUTT HINGES, OR METAL STRAP HINGES, OR IMPROVISED HINGES MADE OF LEATHER, WOVEN STRAPS, CORDS OR FOUR HOOK & EYE SCREWS WHICH CAN BE JOINED TO FORM TWO HINGES.
- \*C. 24 NAILS ABOUT 2" LONG, PLUS SCREWS FOR HINGES.
- \*D. POLYETHYLENE FILM, 3 TO 4 MILS THICK, OR PLASTIC DROP CLOTH, OR RAINCOAT-TYPE FABRIC, OR STRONG HEAVY PAPER — 10 RECTANGULAR-SHAPED PIECES, 30" X 5 1/2".
- \*E. 30' OF SMOOTH, STRAIGHT WIRE FOR USE AS FLAP PIVOT WIRES — (ABOUT AS THICK AS COAT-HANGER WIRE) OR CUT FROM 10 WIRE COAT HANGERS, OR 35' OF NY1 UN STRING (COAT-HANGER WIRE THICKNESS).
- \*F. 30 SMALL STAPLES, OR SMALL NAILS, OR 60 TACKS TO ATTACH FLAP PIVOT WIRES TO WOOD FRAME.
- \*G. 30' OF 1/4" TO 1" WIDE PRESSURE-SENSITIVE WATERPROOF TAPE THAT DOES NOT STRETCH, OR USE NEEDLE AND THREAD TO SEW HEM TUNNELS TO THE FLAPS.
- \*H. FOR FLAP STOPS, 150 FT OF LIGHT STRING, STRONG THREAD, OR THIN SMOOTH WIRE. 90 TACKS OR SMALL NAILS TO ATTACH FLAP STOPS TO THE WOOD FRAME, OR FLAP STOPS CAN BE TIED TO THE FRAME.
- I. 10 FEET OF CORD FOR THE PULL CORD.
- J. DESIRABLE TOOLS: HAMMER, SAW, WIRECUTTER-PLIERS, SCREWDRIVER, SMALL DRILL, SCISSORS, KNIFE, YARDSTICK, AND PENCIL.

\* Items must be sized or adjusted to fit opening into which airpump is to be placed.



**HOW TO CONSTRUCT THE AIR PUMP (CONT'D)**

- C. CUT 10 RECTANGULAR STRIPS 30" LONG BY 5 1/2" WIDE FOR USE AS FLAPS. HEM FLAPS AS SHOWN. USE PRESSURE-SENSITIVE TAPE OR SEW HEM SHUT TO FORM HEM TUNNEL.**

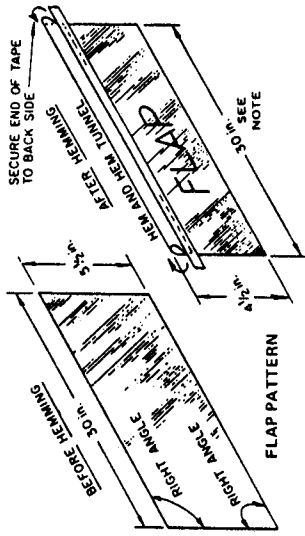

**NOTE: WIDTH OF FRAME PLUS 1 INCH**

- INSERT 10 PIECES OF STRAIGHT WIRE (PIVOT WIRES) INTO FLAP HEM AS SHOWN. FLAPS SHOULD SWING FREELY. STRING CAN BE USED IF WIRE NOT AVAILABLE (WIRE COAT-HANGER THICKNESS).**

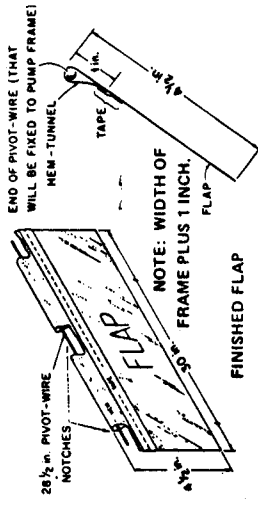

- E. ATTACH FLAP STOPS (STRINGS OR WIRES) TO THE PUMP FRAME AT THE MARKED LOCATIONS. 4 FLAP STOPS ARE NEEDED BETWEEN ADJACENT PIVOT WIRES.**

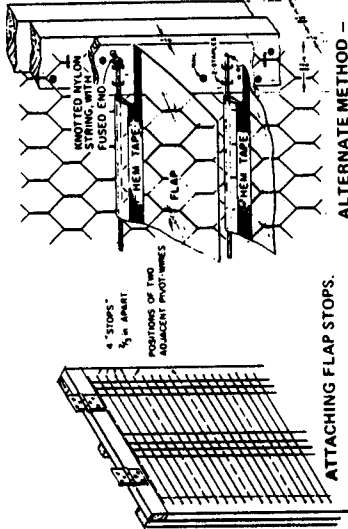

**ATTACHING FLAP STOPS.**

**ALTERNATE METHOD - WIREMESH AS FLAP STOPS.**

- AFTER HEM IS MADE, CUT NOTCHES IN FLAPS AS SHOWN. AVOID CUTTING TAPE THAT HOLDS HEM.**

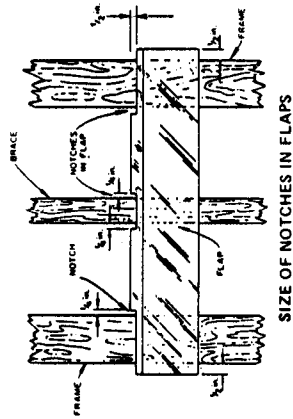

**SIZE OF NOTCHES IN FLAPS**

- D. MARK PUMP FRAME FOR PIVOT WIRE AND FLAP STOP LOCATIONS.**

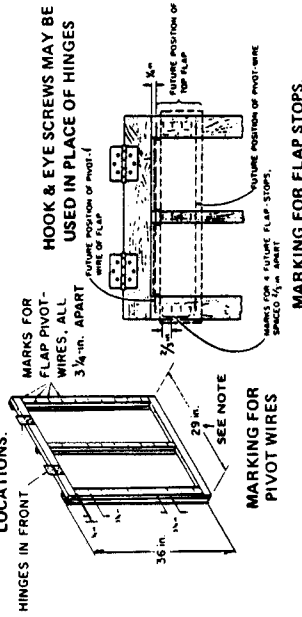

**MARKING FOR FLAP STOPS.**

**NOTE: FRAME DIMENSIONS MAY HAVE TO BE ADJUSTED TO FIT OPENING IN SHELTER**

- F. STARTING FROM THE BOTTOM - STAPLE, NAIL, TACK OR TIE THE FLAP PIVOT WIRES WITH FLAPS IN THEIR MARKED POSITIONS. ATTACH HINGES TO HORIZONTAL SUPPORT BOARD. ATTACH PULLCORD TO CENTER BRACE.**

**STEP 4. TYPICAL INSTALLATION OF AIR PUMP**

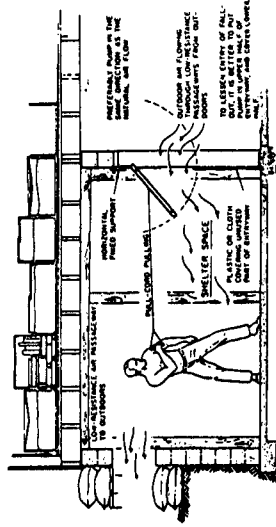

# BUCKET STOVE

THIS COMBINATION COOK-STOVE/SPACE HEATER IS MADE USING A 10 TO 16 qt. METAL PAI  
SOME COAT-HANGER WIRE, AND METAL CUT FROM A LARGE JUICE OR VEGETABLE CAN.  
WHEN ASSEMBLED AS SHOWN, THE STOVE WILL BRING 3 qts. OF WATER TO A BOIL USING AS  
FUEL ABOUT 1/2 lb. OF DRY, TWISTED PAPER OR DRY WOOD. PIECES OF WOOD ABOUT  
1/2 x 3/4 x 6 INCHES ARE BEST.

**NOTE:**  
LOCATE COOK-STOVE ONLY  
WHERE EITHER NATURAL  
OR FORCED VENTILATION IS  
CAUSING AIR TO LEAVE THE  
SHELTER—DO NOT OPERATE  
IN A SEALED SHELTER.

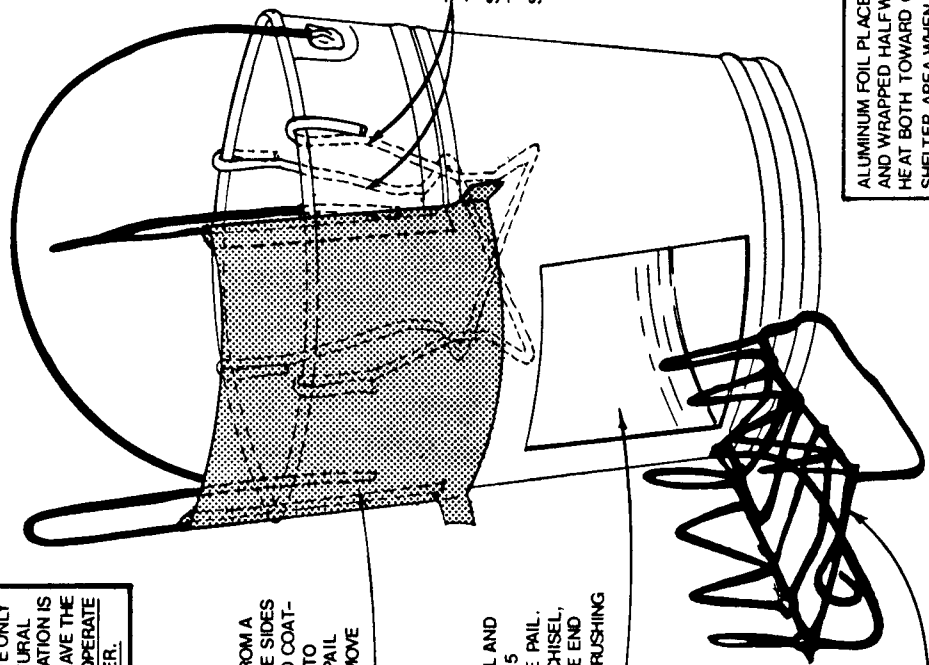

ALUMINUM FOIL PLACED IN BOTTOM OF PAI AND WRAPPED HALF WAY AROUND IT REFLECTS HEAT BOTH TOWARD COOK-POT AND TOWARD SHELTER AREA WHEN DEVICE IS USED AS A SPACE HEATER.

# EMERGENCY LAMP

THIS TYPE OF LAMP WILL PROVIDE LIGHT FOR USE IN EXPEDIENT SHELTERS — THE LAMP WILL BURN SLOWLY CONSUMING ABOUT 3 OUNCES OF COOKING OIL IN 24 HOURS.

**WARNING**  
DO NOT USE KEROSENE, DIESEL FUEL, OR GASOLINE — USE ONLY OILS OF THE KIND FOUND IN THE KITCHEN.

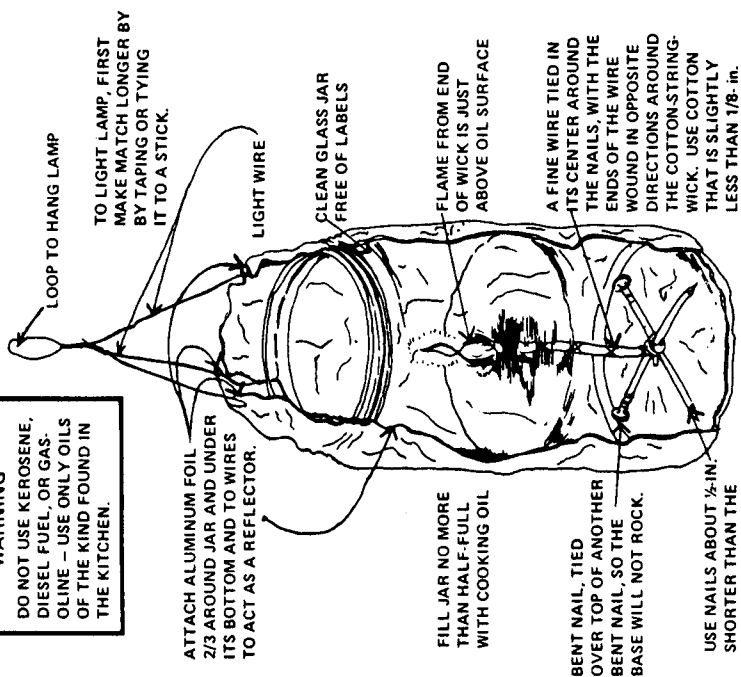

WIRE-STIFFENED-WICK LAMP

KEEP EXTRA WIRE AND WICK-STRING IN SHELTER.

Hello!

If you are viewing this document on a CD purchased from an ebay seller you could have downloaded it for **FREE** at

[www.civildefensemuseum.com](http://www.civildefensemuseum.com)

Just thought you might like to know where this seller is getting their material.

Thanks

Eric Green

The Civil Defense Museum